

Assembly Instruction Sheet #IS-8318P50

For Style 8318P50

Tools Required: Flathead screwdriver, Phillips screwdriver, pliers, wire cutters, wire strippers, electrical tape, safety glasses.

Light Source: (41) E12 Candelabra Base Bulbs 60W Maximum(Not Include).



Estimated Assembly Time: 20-30 minutes







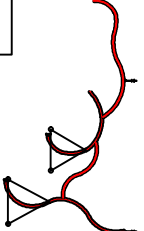
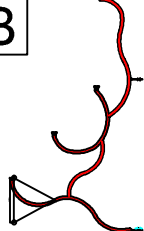
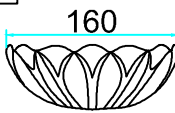

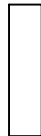
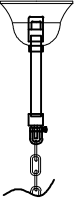
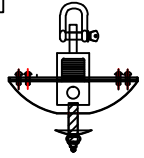
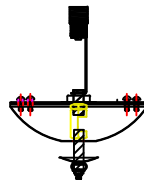





Preparation: Identify and inspect all parts before beginning installation. Check package content list and diagrams below to be sure all parts are present. If any parts are missing or damaged, do not attempt to assemble, install, or operate the fixture. Contact customer service for replacement parts.

⚠ Warnings and Cautions

Turn off electricity at circuit breaker or main fuse box before installation. Consult a licensed electrician if in doubt. These instructions are provided for your safety. It is very important you read them completely before installing the fixture. We strongly recommend that a licensed, professional electrician perform the installation. Disconnect fixture from power source before replacing bulbs. Make sure bulbs are given sufficient time to cool before removal.

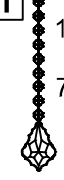
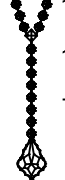
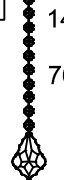
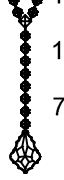
Package Contents

A  QTY X 5 Arms	B  QTY X 5 Arms	C  QTY X 2 Bobeches	D  QTY X 40 Bobeches	E  QTY X 41 Candle Covers
F  QTY X 1 Ceiling Canopy	G  QTY X 1 Part	H  QTY X 1 Part		

<p>1</p> <p>14MMX3PCS 76MMX1PCS</p>  <p>QTY X 10</p> <p>Crystal</p>	<p>2</p> <p>14MMx9PCS 16MMx1PCS 76MMx1PCS</p>  <p>QTY X 10</p> <p>Crystal</p>	<p>3</p> <p>14MMx2PCS 76MMx1PCS</p>  <p>QTY X 10</p> <p>Crystal</p>	<p>4</p> <p>14MMx7PCS 16MMx1PCS 76MMx1PCS</p>  <p>QTY X 10</p> <p>Crystal</p>	<p>5</p> <p>14MMx2PCS 76MMx1PCS</p>  <p>QTY X 15</p> <p>Crystal</p>
<p>6</p> <p>14MMx9PCS 16MMx1PCS 76MMx1PCS</p>  <p>QTY X 15</p> <p>Crystal</p>	<p>7</p> <p>14MMx3PCS 76MMx1PCS</p>  <p>QTY X 20</p> <p>Crystal</p>	<p>8</p> <p>14MMx9PCS 16MMx1PCS 76MMx1PCS</p>  <p>QTY X 20</p> <p>Crystal</p>	<p>9</p> <p>14MMx6PCS 16MMx1PCS 76MMx1PCS</p>  <p>QTY X 10</p> <p>Crystal</p>	<p>10</p> <p>14MMx12PCS 16MMx1PCS 76MMx1PCS</p>  <p>QTY X 10</p> <p>Crystal</p>
<p>11</p> <p>14MMx10PCS 76MMx1PCS</p>  <p>QTY X 10</p> <p>Crystal</p>	<p>12</p> <p>14MMx18PCS 16MMx1PCS 76MMx1PCS</p>  <p>QTY X 10</p> <p>Crystal</p>	<p>13</p> <p>14MMx11PCS 76MMx1PCS</p>  <p>QTY X 10</p> <p>Crystal</p>	<p>14</p> <p>14MMx14PCS 16MMx1PCS 76MMx1PCS</p>  <p>QTY X 10</p> <p>Crystal</p>	<p>15</p> <p>14MMx12PCS 76MMx1PCS</p>  <p>QTY X 10</p> <p>Crystal</p>
<p>16</p> <p>14MMx13PCS 40MMx1PCS</p>  <p>QTY X 1</p> <p>Crystal</p>	<p>17</p> <p>14MMx7PCS 40MMx1PCS</p>  <p>QTY X 1</p> <p>Crystal</p>	<p>18</p> <p>14MMx1PCS 50MMx1PCS</p>  <p>QTY X 160</p> <p>Crystal</p>		

STEP 1

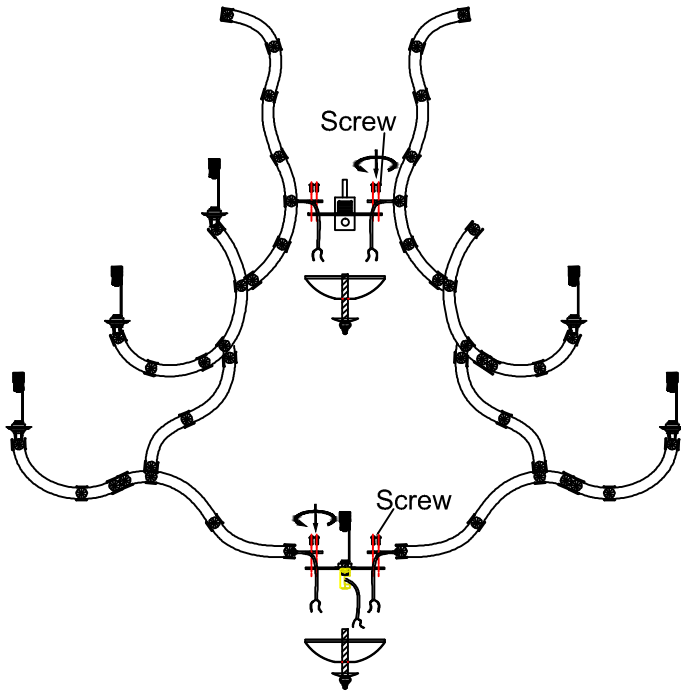

PARTS

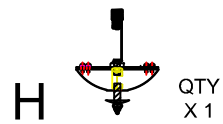
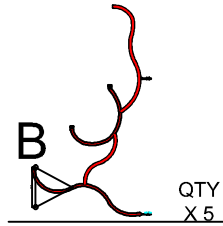
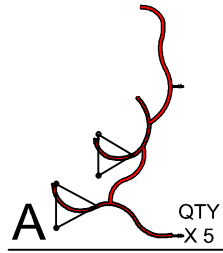

NOTE

assemble parts as shown

STEP 2

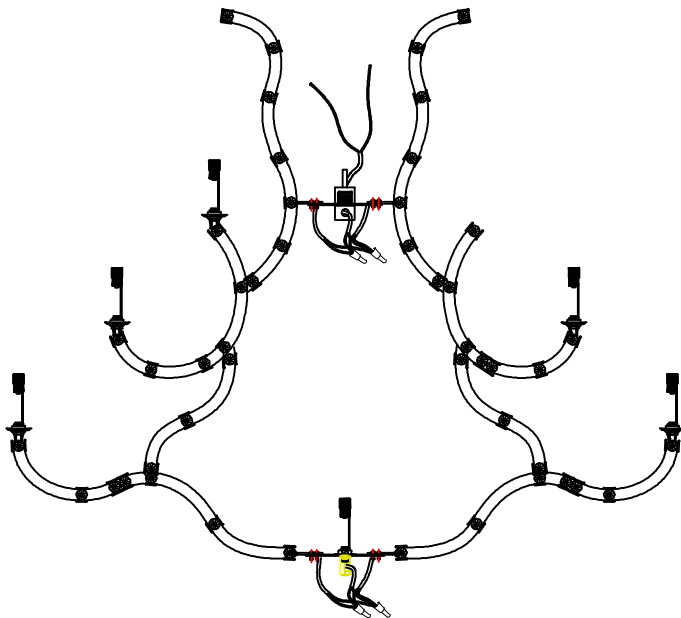

PARTS

NOTE

assemble parts as shown

STEP 3

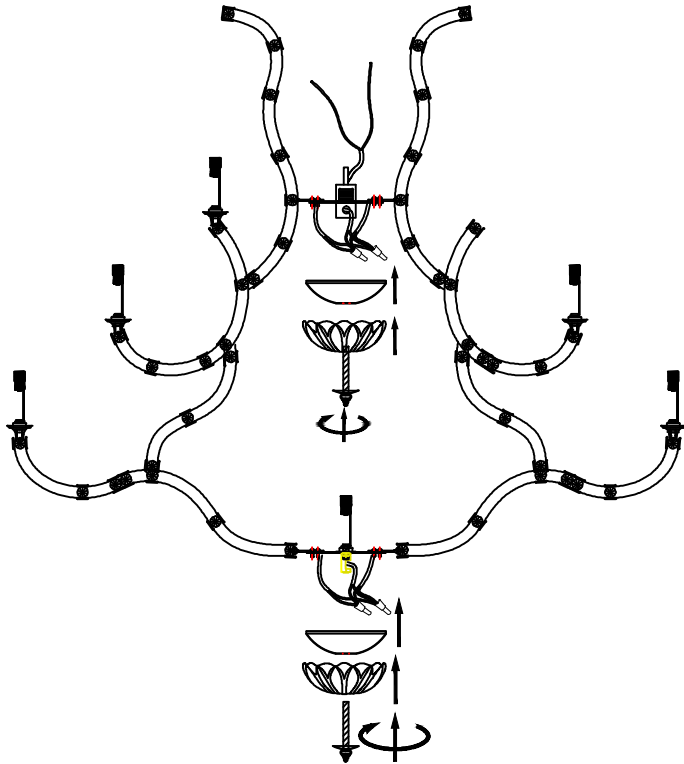

PARTS

NOTE

assemble parts
as shown

STEP 4

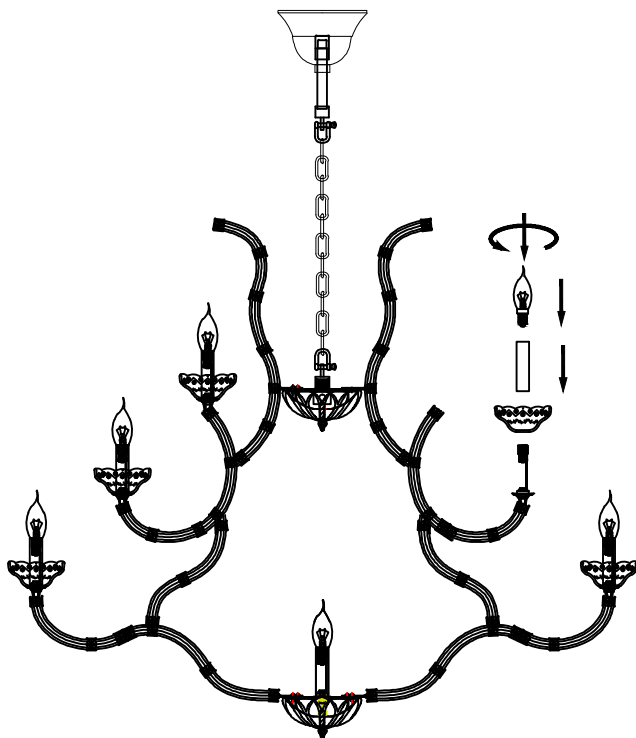

PARTS

NOTE

assemble parts
as shown

STEP 5

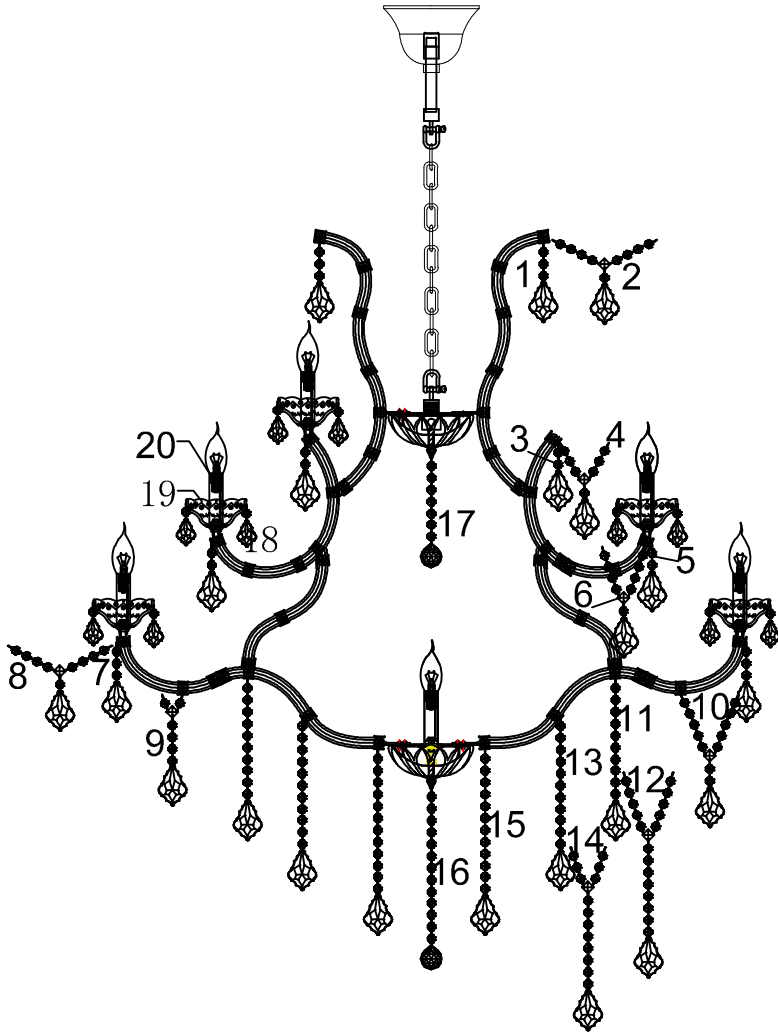

PARTS

NOTE

assemble parts
as shown

PARTS

NOTE

assemble parts
as shown